

**Demonstration of Color Constancy in Photographs by Two Techniques:
Stereoscope and D-up Viewer**

Chanprapha PHUANGSUWAN, Mitsuo IKEDA, and Hiroyuki SHINODA

OPTICAL REVIEW Vol. 21, No. 6 (2014)

Measurement of Color Constancy in Photography by Two Techniques:
Spectrophotometry and D-50 Viewing
George J. Johnson, Thomas D. McIlroy, and Richard S. Steinhilber

MI 4

OPTICAL REVIEW VOL 21, NO 2, 1974

Demonstration of Color Constancy in Photographs by Two Techniques: Stereoscope and D-up Viewer*

Chanprapha PHUANGSUWAN¹, Mitsuo IKEDA¹, and Hiroyuki SHINODA²

¹Color Research Center, Faculty of Mass Communication Technology, Rajamangala University of Technology, Thanyaburi, Pathumthani 12110, Thailand

²Department of Human and Computer Intelligence, College of Information Science and Engineering, Ritsumeikan University, Nojihigashi, Kusatsu, Shiga 525-8577, Japan

(Received September 27, 2013; Revised July 15, 2014; Accepted August 21, 2014)

When we look, under daylight, at a scene in a photograph taken under an incandescent lamp, it appears very reddish, showing that color constancy is not maintained. According to the recognized visual space of illumination (RVSI) concept, color constancy should exist in a photograph if one can perceive three dimensions in it. This prediction was confirmed by applying two viewing techniques to perceive a 3D space in a 2D photograph: a stereoscope viewed with two eyes and a D-up viewer viewed with one eye. A wide range of illumination color was investigated, covering range from vivid blue through to vivid orange, and the color constancy index became larger with the 3D perception than with the 2D perception of the photographs produced by the two techniques. © 2014 The Japan Society of Applied Physics

Keywords: color constancy, photograph, illumination, stereoscope, recognized visual space of illumination

1. Introduction

Color constancy is a well-known and important property of our visual system and many people have studied it and proposed mechanisms to explain it. One explanation is based on the concept of the recognized visual space of illumination (RVSI) developed by Ikeda and co-workers.¹⁻⁵⁾ The concept emphasizes the recognition of a 3D space in which objects are placed and the understanding of the illumination filling the space. The visual system then adapts to the illumination and not to the color of objects.⁶⁾ The adaptation eventually gives the visual system the property of color constancy for the objects.

It is known that color constancy does not normally take place for a photograph.⁷⁾ When a photograph is taken in a room illuminated by an incandescent lamp and later viewed in a room illuminated by a daylight type lamp, the photograph appears very reddish, contrary to the color experience in the room where the photograph was taken. Referring to the RVSI theory, Mizokami et al.⁸⁾ and Phuangsuwan et al.⁹⁾ showed that color constancy exists in a photograph if one can perceive a 3D space in the photograph. To perceive the 3D space they employed a D-up viewer^{8,9)} with which a subject looked at a photograph with one eye, or monocularly, in the viewer so that the subject viewed only the photograph without seeing any surroundings of the photograph. The brain automatically changed the 2D retinal image of the photograph to a 3D scene, and the subject perceived a white object in the photograph as being almost white in spite of the fact that the object was reddish in the photograph when measured with a color luminometer. Brainard and co-workers insisted that

experiments on color constancy be conducted in a real room.¹⁰⁻¹³⁾

There are some other ways to perceive a 2D photograph as a 3D scene besides the use of a D-up viewer. The most common technique is to use a stereoscope that employs two photographs taken with the parallax of two eyes, which are viewed binocularly with the respective eyes. In the present study, we employed the stereoscopic technique to confirm color constancy in photographs with 3D perception for a wide range of illumination color from vivid blue through to vivid orange roughly along the Planckian locus. The experiment was carried out at Ritsumeikan University of Japan. In the previous study,⁹⁾ which was carried out at Chulalongkorn University of Thailand, only the orange region was investigated. The additional experiment for the blue region was conducted at a later time at Chulalongkorn University to complete the range of illumination; the results will be shown in the present paper in order to confirm the color constancy in photographs with both the stereoscope and the D-up viewer and for both blue and orange regions of illumination.

2. Apparatus

Two different sets of apparatus were used, one at Chulalongkorn University (Chula) and the other at Ritsumeikan University (Rits). The former apparatus was used for the orange region of illumination in the previous study⁹⁾ and the explanation of the apparatus was already presented in the paper. Here the apparatus was used again for the blue region of illumination by employing a blue film. The apparatus used at Rits is shown in Fig. 1. In the observing room Ro, a subject observed the inside of the room, which was illuminated by a ceiling light of a certain color. Various colors were produced by adjusting the relative intensities of a white fluorescent lamp of three bands type, Lw1, and two fluorescent lamps Lc of the same type as Lw1 but covered with the blue or orange film brought from Chula.

*The experiment with the stereoscope was conducted at Ritsumeikan University during the senior author's 10-month term as a visiting researcher, and the experiment with the D-up viewer was conducted at Chulalongkorn University when she was a PhD student.

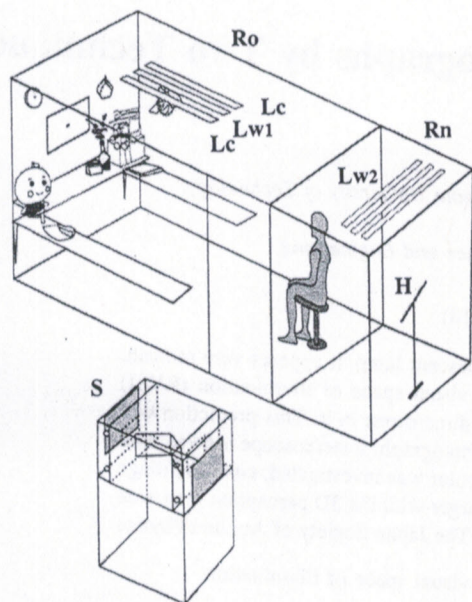

Fig. 1. Schematic view of apparatus for the Rits experiment. H, photograph holder for normal viewing condition; S, stereoscope.

The side walls of the room were covered with white wallpaper and the ceiling was covered with a black curtain. Various objects were placed in the room such as a doll, artificial flowers, books, and a clock to simulate a normal room. The size of the room was 130 cm wide, 220 cm long, and 200 cm high. Behind the observing room, another room, Rn, with 100 cm length was prepared, separated by a black curtain, for the normal viewing experiment. Its walls and ceiling were covered with black cloth. Three fluorescent lamps, Lw2, of the same type as Lw1 were placed at the ceiling without a color film.

Just outside the observing room, stereoscope S was placed so that the subject could look into it quickly upon moving out from the observing room. A chin rest was prepared to fix the position of the subject's head. The stereoscope comprised two first surface mirrors 40 cm wide and 20 cm high in contact at the edges forming an apex angle of 90° . On the two sides of the mirrors, photographs of the observing room Ro were placed and illuminated from above and below by fluorescent lamps of the same type as Lw1. Windows placed in front of the photographs limited the visual size to 40 cm wide and 20 cm high. The total viewing distance from the subject's eyes to the photographs was 56 cm. The overall size of the stereoscope was 65 cm wide, 68 cm long, and 66 cm high. Care was taken to show only the photographs to the subject. The subject could perceive a 3D scene of the observing room once his head was properly positioned.

The photographs of the observing room illuminated in various colors were taken beforehand from positions corresponding to the subject's eyes with a 6 cm horizontal separation. The horizontal plane illuminance on the front shelf was kept constant at 80 lx. Colors of room illumination are shown by the lower series of circles connected by solid lines in Fig. 2. The upper series shows the colors employed

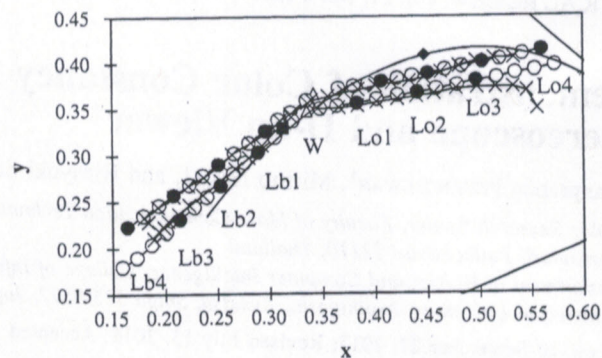

Fig. 2. Illumination colors of the observing room (circles) and photograph colors (crosses). Illuminations investigated are shown by filled circles. Upper series: the Chula experiment; lower series: the Rits experiment. Open triangles show the white illumination of the Rits and Chula experiment. The filled diamond and filled square show the CIE standard illuminants, A and D65, respectively.

in the Chula experiment. A solid curve shows the Planckian locus ending at the color temperature of ∞ K. The filled diamond indicates CIE illuminant A, and the solid square indicates CIE illuminant D65. The total number of colors for room Ro was 26, 13 in the blue region and 13 in the orange region. They were measured at the white front wall of the subject room with a color luminometer (Konica Minolta CL200). Open triangles indicate the white color of the wall when only Lw1 was lit. A slight difference in color between Rits and Chula is observed, probably because of the different color of the ceiling. At Rits, the ceiling was covered with a black curtain, whereas at Chula, it was a light brown wood board. Under the 26 illuminations, photographs were taken and the color at the same point on the front wall in the photographs was measured, and is shown by the symbol \times in Fig. 2. The exact correspondence of colors between the real room and in the photographs is poor at some points but they fall on the same lines, except for two or three points at the extreme orange side in the Rits apparatus. In the present paper, we specify the color of photographs by the chromaticity coordinates and not by the numbers of the photographs. The lack of correspondence does not present a serious problem.

3. Procedure

In the Rits experiment, six colors were employed for the observing room, Lb3, Lb2, Lb1, Lo1, Lo2, and Lo3, at the illuminance of 80 lx, as indicated by filled circles in the lower series of illumination in Fig. 2. A subject binocularly observed the inside of the observing room lit with one of these above lights for a few minutes until he/she was sure about the color appearance of the room. The subject wore a cap so that the ceiling lamps would not be seen, in order to eliminate direct information about the illumination color. The subject was asked to look around the room, and to not limit the observation to one particular object in the room, and to remember the color appearance of the room as a whole. Then the subject left the room and looked into the

stereoscope, properly adjusting his head position with the help of the chin rest so that left and right photographs fused into one. When the subject reported that he could see a 3D scene of the observing room, he was asked to report the color appearance of the virtual room as either "bluer than the real room" or "whiter than the real room" for the blue series of photographs, and "redder" or "whiter" for the orange series of photographs. The experimenter exchanged the pair of photographs randomly with another pair for the next judgment to investigate several pairs of photographs at one time. The experiment was repeated ten times at a different time or day. We call this experiment the 3D experiment.

Another experiment was conducted, which we call the 2D experiment. After observing the color appearance of the observing room as in the case of the 3D experiment, the subject moved to the normal viewing room, where a photograph was presented on photograph holder H in Fig. 1. The luminance on the front wall of both the real room and the photograph was made approximately equal, which required a horizontal plane illuminance of 377 lx on the photograph in the holder. The subject observed the photograph with both eyes and responded similarly to in the 3D experiment, such as "bluer" or "whiter". The experimenter changed photographs randomly and several photographs were investigated for one illumination color of the real room at one time. The observation was repeated ten times for each illumination. In both the 3D and 2D experiments, subjects could observe the real room as much as they wanted to give a confident response.

Five subjects participated in the experiment, ON, KR, CP, VS, and JP. Subject ON was a Japanese student and KR, CP, and VS were foreign students from Thailand. JP is the senior author of this paper and participated in the previous experiment for the orange series conducted at Chula. She instructed the other three Thai subjects in the experiment in Thai and the Japanese subject in English. All the subjects had normal color vision as tested by the 100 hue test.

In the Chula experiment, the blue series was investigated using the same D-up viewer as before, for four blue room illuminations, Lb1 through Lb4, shown by filled circles in the upper series of illumination in Fig. 2. The instruction given to the subjects for observing the observing room was the same as in the Rits experiment, but that for observing photographs in the D-up viewer was slightly different. It took a few seconds or longer for a subject to attain depth perception in a photograph, unlike in the case of the stereoscope, which provided a 3D scene instantly whenever the fusion of two images was achieved. The subject was instructed to consider their response only after a stable 3D scene of the observing room with the same depth perception as for the real room was achieved. The response to be given was the same as in the Rits experiment, namely, "bluer than the real room" or "whiter than the real room".

For the 2D experiment or the normal viewing experiment at Chula, a photograph was observed inside the observing room at the back of the room under daylight-type lamps. The experiment was conducted in the same way as the Rits experiment.

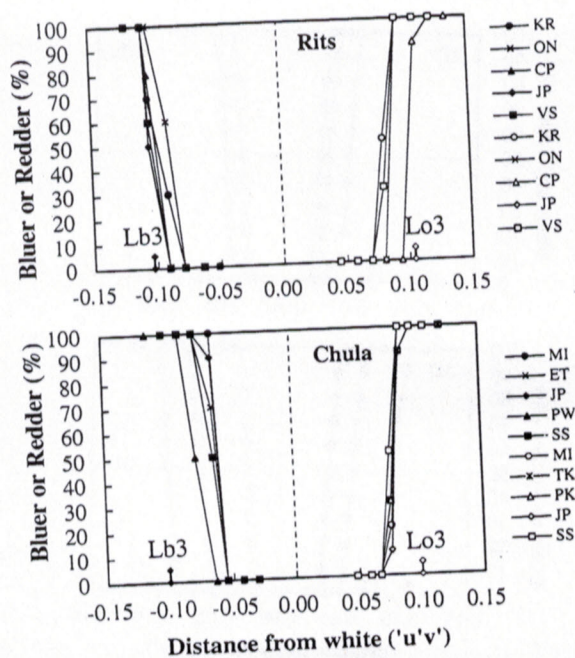

Fig. 3. Bluer and redder probability-of-seeing curves for the room illuminations Lb3 and Lo3 obtained in the 3D experiment. Upper section: Rits; lower section: Chula. Subjects are given on the right.

Five subjects, SS, JP, PW, ET (all Thai), and MI (Japanese), with normal color vision participated in the Chula experiment. Subject MI is coauthor of the present paper. Subjects SS, JP, and MI also participated in the previous orange series experiment.

4. Results and Discussion

From the ten responses of one subject for each photograph, a probability-of-seeing curve of bluer or redder was obtained, as shown in Fig. 3, as examples for room illuminations Lb3 and Lo3 and for the 3D experiment. The upper section shows the results from the Rits experiment and the lower section shows those from the Chula experiment. The right-hand curves of the Chula results were obtained in the previous experiment.⁹⁾ The abscissa gives the distance of colors in the photographs measured from the white color shown by open triangles in the Rits and Chula illumination series in Fig. 2. The CIE $u'v'$ diagram was used to calculate the distance. A distance in the blue region is indicated by a negative sign. Colors of room illuminations Lb3 and Lo3 are shown on the abscissa by filled diamonds and open diamonds for blue and orange regions, respectively. The ordinate gives the percentage of the bluer or redder response for photographs calculated from the ten responses. We covered at least six photographs to obtain one probability-of-seeing curve. The five curves at the blue and orange regions show the results for the five subjects.

The variance among the subjects is not large, as will be shown later by the standard deviation in Fig. 6. The slopes of the curves are sharp in Fig. 3. In other words subjects

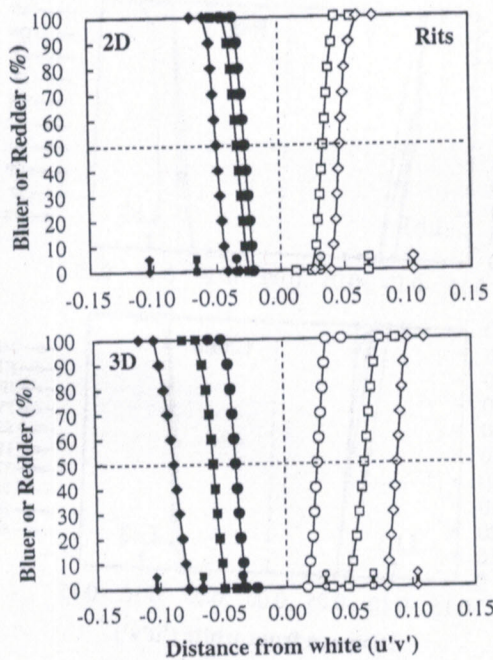

Fig. 4. Averaged bluer and redder probability-of-seeing curves for five subjects obtained at Rits. Upper: normal viewing or 2D condition; lower: stereoscopic or 3D condition.

noticed a clear color appearance difference of the photographs as early as one or two steps of the series. The curves of the blue region of the Rits experiment came close to the color of the room illumination, indicating that the subjects judged photographs of which color was close to that of the real room. Even if the subjects looked at a rather bluish photograph, they perceived the room to be white in the photograph, same as their perception of the real room lit by a blue color. Color constancy thus existed for the photograph as for the real room. The agreement between the illumination color and the color of the photograph is poorer under other conditions. The subjects judged photographs to be a little whiter than the real room, implying weaker color constancy than that for the real room.

The average of five probability-of-seeing curves of subjects was calculated at steps of 10% by interpolating the values between the data available. The results from the Rits experiment, where the stereoscope was used, are shown in Fig. 4, the upper section showing 2D experiments and the lower section showing 3D experiments. On the abscissa, six colors of the real room are shown by a filled diamond, filled square, filled circle, open circle, open square, and open diamond for Lb3, Lb2, Lb1, Lo1, Lo2, and Lo3, respectively. The probability-of-seeing curves for these colors are shown by the same symbols. For the Lo1 condition in the 2D experiment, some subjects responded 100% "redder" for the photograph closest to white and the average curve was not obtainable. All five curves for the 2D experiment came closer to the white point, shown by a distance of 0, indicating that subjects chose much whiter photographs than the corresponding room colors. In contrast, the curves in the 3D experiment came close to the respective colors of the

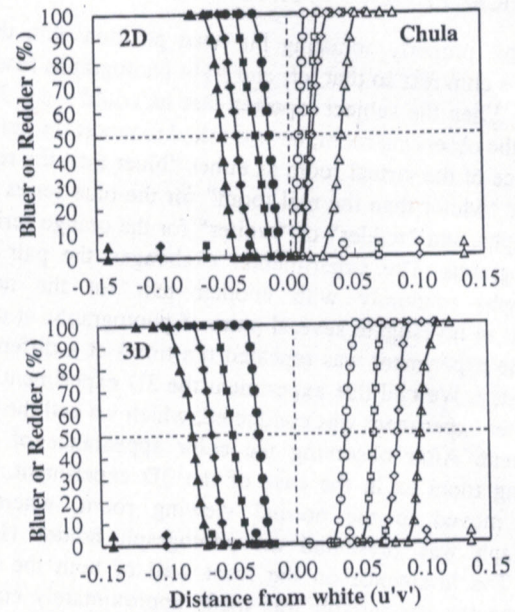

Fig. 5. Averaged bluer and redder probability-of-seeing curves for five subjects obtained at Chula. Upper: normal viewing or 2D condition; lower: D-up viewer or 3D condition.

room illuminations, implying that color constancy existed for photographs when subjects could perceive a space in the photographs. The results from the Chula experiment where the D-up viewer was used are shown in Fig. 5, and they are similar to those from the Rits experiment.

The distance of the photograph from white was read out at 50% for each curve in Figs. 4 and 5 to see how close it was to the distance of room illumination and was plotted for each room illumination color in Fig. 6, the upper section for Rits and the lower section for Chula. Filled circles indicate the 2D experiment and open circles indicate the 3D experiment. The 45° dotted line indicates that the color constancy in the photograph is the same as that for the real room and the horizontal line at 0 of the ordinate indicates that the photograph color chosen is white, which implies no color constancy. The standard deviation for the five subjects is shown by a short vertical bar at each point. The 3D results, shown by open circles, are closer to the 45° dotted line than 2D results, implying better color constancy.

To determine the degree of color constancy quantitatively, we defined the color constancy index (CI) similarly but not equal to those of Arend et al.¹⁴⁾ and Brainard,¹²⁾ as

$$CI = d_p/d_i,$$

where d_p is the distance of the photograph from white and d_i the distance of the illumination from white. A CI of unity implies that the color constancy in the photograph is the same as that for the real room. Lower values than unity imply that the color constancy in the photograph is lower than that for the real room. It should be pointed out that the CI introduced here is an index for comparing the color constancy in a photographic photograph with that in a real

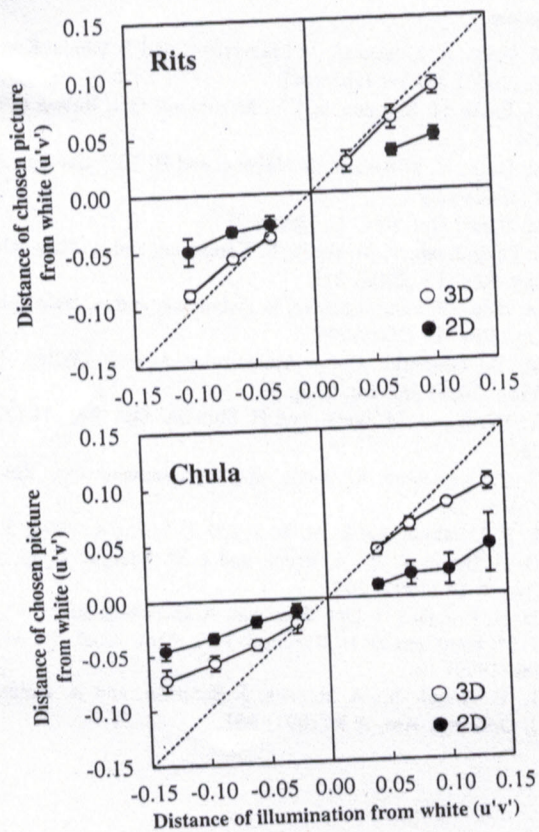

Fig. 6. Distance of the chosen photographs from white plotted against the distance of the illumination color from white in the $u'v'$ diagram. The mean results of five subjects are shown. Upper: Rits; lower: Chula. Filled circles: 2D experiment; open circles: 3D experiment.

space. The results are shown in Fig. 7 in the upper section for the Rits experiment and in the lower section for the Chula experiment, with the standard deviations of the five subjects given by vertical bars. The standard deviation became large for a short distance of the illumination compared with that in Fig. 6 because of the definition of CI. The distance of the room illuminance close to white became small while the standard deviation remained about the same, as seen in Fig. 6, except for the 2D results of the orange side. Consequently, the standard deviation of CI became large.

It is clear from Fig. 7 that all the 3D points are nearer to the $CI = 1$ line than the 2D points, indicating that the color constancy is greater under the 3D viewing condition than that under the 2D or normal viewing condition. We tested the difference between 3D and 2D by the t-test at $\alpha = 0.05$. There was only one pair among 13 pairs of 3D and 2D results of CI, the pair at Lb1 in the Chula results, that showed no significant difference ($T_{4,0.05} = -2.338$, $p > 0.05$). The pair of Lb1 in the Rits results showed a significant difference ($T_{4,0.05} = -3.554$, $p < 0.05$).

Some of the 3D CI values are very close to unity and we tested whether they are different from $CI = 1$ by the t-test at $\alpha = 0.05$. In the Rits experiment, the points at Lb1, Lo1, and

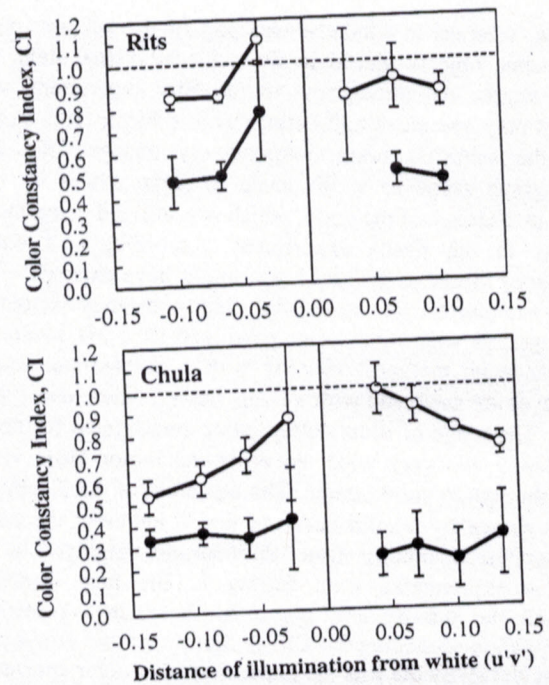

Fig. 7. Color constancy index CI plotted against the distance of illumination from white in the $u'v'$ diagram. Filled circles: 2D experiment; open circles: 3D experiment. Upper: Rits; lower: Chula.

Lo2 showed no significant difference ($T_{4,0.05} = -2.489$, $p > 0.05$ for Lb1, $T_{4,0.05} = 1.161$, $p > 0.05$ for Lo1, and $T_{4,0.05} = 1.202$, $p > 0.05$ for Lo2). In the Chula experiment, the points at Lb1 and Lo1 showed no significant difference ($T_{4,0.05} = -0.539$, $p > 0.05$ for Lb1 and $T_{4,0.05} = 1.019$, $p > 0.05$ for Lo1). These photographs gave the same color constancy as for the real space when they were perceived as 3D space. The 3D CI values in the Chula results appear to decrease with increasing saturation of the illumination color. However, a significant difference was found by the t-test for the pairs of Lb1 and Lb4, Lb2 and Lb3, and Lb2 and Lb4, but not for other pairs. We can conclude that the CI value decreases for a more saturated color of illumination but cannot describe the decrease in detail.

The CI values in the 2D experiment in the Chula results are almost completely unaffected by the saturation. No significant difference was found for any pair of four points in either the blue or orange region, except the two pairs of Lb3 and Lb4, and Lo3 and Lo4. In the Rits results, two points on the orange region showed no significant difference at $\alpha = 0.05$, but on the blue region, the CI value at Lb1 was significantly higher than the other two values, indicating a different influence of the saturation.

There is a difference in the results of the 2D experiment between Rits and Chula in Fig. 7. The average of four CI values at Lb3, Lb2, Lo2, and Lo3 in the Rits case and that of eight CI values in the Chula case are 0.48 and 0.32, respectively. The color constancy in the Rits results showed a larger value. We can point out that the room for the normal viewing experiment in Rits was surrounded by a black

curtain, whereas in Chula, it was part of the subject room with some objects placed in the subjects' visual field. In other words, the photograph in the Rits experiment was almost only one meaningful stimulus to subjects. It is likely that the subject's brain automatically changed the 2D photograph scene to a 3D scene to some extent by the D-up mechanism of the brain, which was utilized in the D-up viewer in the Chula experiment. Accordingly, a color constancy closer to the real room might have existed.

To summarize, we showed that color constancy existed in photographs when they were perceived as a 3D scene by both viewing methods: viewing with a stereoscope, where two eyes are used, and with a D-up viewer, where one eye is used. The range of illumination color investigated for color constancy was very wide, covering the region from vivid blue through to vivid orange. The end point of the Planckian locus shown by a solid curve in Fig. 2 indicates the color temperature of infinity. Blue illuminations employed in the present experiments went further in the blue direction beyond the infinity end point. In the orange direction, illumination exceeding the CIE A illuminant was employed. It was shown by the Rits 3D experiment that color constancy was still close to that of the real room, if not the same, under these extreme colors of illumination, indicating the good adaptability of the visual system to color illumination.

References

- 1) M. Ikeda, K. Motonaga, N. Matsuzawa, and T. Ishida: *Kogaku* **22** (1993) 289 [in Japanese].
- 2) M. Ikeda, H. Shinoda, and Y. Mizokami: *Opt. Rev.* **5** (1998) 380.
- 3) M. Ikeda, Y. Mizokami, S. Nakane, and H. Shinoda: *Opt. Rev.* **9** (2002) 132.
- 4) M. Ikeda: *Opt. Rev.* **11** (2004) 217.
- 5) P. Punggrassamee, M. Ikeda, P. Katemake, and A. Hansuebsai: *Opt. Rev.* **12** (2005) 211.
- 6) M. Ikeda, P. Punggrassamee, P. Katemake, and A. Hansuebsai: *Opt. Rev.* **13** (2006) 388.
- 7) M. D. Fairchild: *Color Appearance Models*. (Wiley, New York, 2005) 2nd ed., Chap. 8.
- 8) Y. Mizokami, M. Ikeda, and H. Shinoda: *Opt. Rev.* **11** (2004) 288.
- 9) C. Phuangsuwan, M. Ikeda, and P. Katemake: *Opt. Rev.* **20** (2013) 74.
- 10) P. B. Delahunt and D. H. Brainard: *J. Vision* **4** (2004) 57.
- 11) D. H. Brainard, W. A. Brunt, and J. M. Speigle: *J. Opt. Soc. Am. A* **14** (1997) 2091.
- 12) D. H. Brainard: *J. Opt. Soc. Am. A* **15** (1998) 307.
- 13) J. M. Kraft and D. H. Brainard: *Proc. Natl. Acad. Sci. U.S.A.* **96** (1999) 307.
- 14) L. E. Arend, Jr., A. Reeves, J. Schirillo, and R. Goldstein: *J. Opt. Soc. Am. A* **8** (1991) 661.